

LIGHTS ON



Scan Studio® Lighting



 **Scan Studio® Lighting**

Scan Studio Lighting ApS
Damgaardvej 2
Dk-5500 Middelfart

Tel.: +45 63 41 88 88
Fax: +45 63 41 88 00

l@scanstudio.dk
www.scanstudiolighting.dk



SET YOUR SCENE

*Flexible light in your home
by Scan Studio Lighting*

ONE ROOM

Multiple light settings

CLICK
YOUR
LIGHT ON
AND OFF
AS YOU
PLEASE. 



MAGNETLINE

- Silver matt or chrome coloured iron rails with magnetic flexibility
- Easily click on and off your pendants, spots, etc.





ONE ROOM

Multiple Light settings



PROLINE 230V

- Aluminium rails available in three colours:
Black / White / Silver



DANISH
QUALITY
LIGHTING



ONE ROOM - MULTIPLE LIGHT SETTINGS	4
NEW PRODUCTS 2014	8
INTRODUCTION	10
SCAN STUDIO CLASSICS	12
■ MAGNETIC FLEXIBLE RAIL SYSTEM 12V	14
MAGNETLINE SYSTEM	14
HOW TO CLICK ON AND OFF	16
SPOTS FOR MAGNETLINE	18
PENDANTS FOR MAGNETLINE	38
ACCESSORIES	67
KITS READY TO GO	70
MICRO MAGNETLINE	76
■ PROLINE RAIL SYSTEM 220V	78
PROLINE SYSTEM	78
PENDANTS FOR PROLINE	84
SPOTS FOR PROLINE	96
ACCESSORIES	101
■ OTHER LIGHTING PRODUCTS	102
CEILING AND WALL LAMPS	106
FLOOR AND TABLE LAMPS	110



SEE OUR
NEW
PRODUCTS
ON
PAGE **8**





MAGNETLINE

12V magnetic flexibility

Scan Studio® Lighting





PROLINE 230V

Scan Studio® Lighting

NEW

PRODUCTS
BY SCAN
STUDIO
LIGHTING

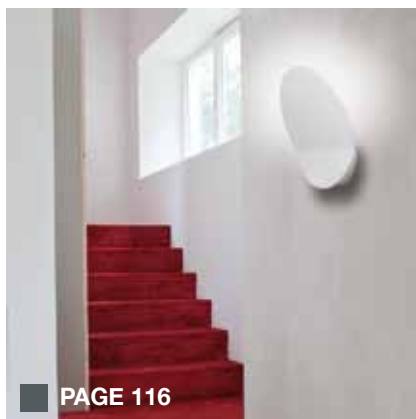

INTRODUCT



ABOUT US

SCAN STUDIO LIGHTING

We are a Danish company that are passionate about lighting. Since we started 30 years ago it has been our ambition to make flexible quality lighting, design that lasts - simple and clean. And to introduce daylight into your home.

We have designed and built the magnetic system (Magnetline and Microline). We have a deep technical expertise in light. To add the extra design look and feel we cooperate with leading Danish pendant and lamp designers.

The catalogue is divided into three parts.

- Orange part: Magnetic rail flexibility (12V).
- Turquoise part: Proline rail (230V).
- Grey part: Other light products that we also offer - like table lamps, plafonds, etc.

You are always welcome to contact us with your questions and specific needs. Please enjoy!



WHY MAGNETIC 12V

MAGNET & MICROLINE – BY SCAN STUDIO LIGHTING

Easily click on and off your lights and pendants (no electrician needed).

A transformer changes the electric power into 12V - which makes it touchable and completely safe.

Timeless look and Danish design by Scan Studio Lighting.

The rails can be angled in many ways – and can even be mounted on sloping walls.

Contact us for your specific measurements and we will help you design your rail system.

See page 14.

ION

Contact us for your specific ceiling measurements, and we will help you design your unique flexible rail system.

Scan Studio Lighting / Damgaardvej 2 / DK-5500 Middelfart
Tel. +45 63 41 88 88 / Fax. +45 63 41 88 00
l@scanstudio.dk / www.scanstudiolighting.dk



WHY PROLINE 230V

– BY SCAN STUDIO LIGHTING

Electric power, 230V, the standard system for most homes. No transformer is needed. Turn off all electric power whenever you wish to change the spot light and pendants in your rail system.

This rail system comes in three colours: Black, silver and white.

The rails can be angled in 90 degree bends and only on regular surfaces.

Contact us for your specific measurements and we will help you design your rail system.

See page 78.



OTHER LIGHTING PRODUCTS

LED DOWNLIGHTS, PLAFONDS, WALL, TABLE, PENDANTS AND FREE STANDING LAMPS

– BY SCAN STUDIO LIGHTING

Plafonds, wall lamps and other lights matching the Scan Studio designs. Here you find the extras that makes it possible to combine the pendants used in either the magnetic or regular rail systems with e.g. a free standing lamp.

You are always welcome to contact us with your specific needs.

See page 102.

DESIGNED
TO
FIT
YOUR
HOME

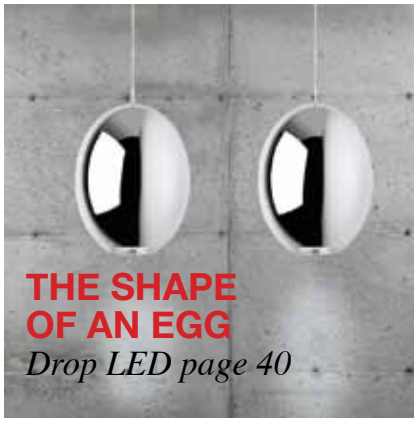

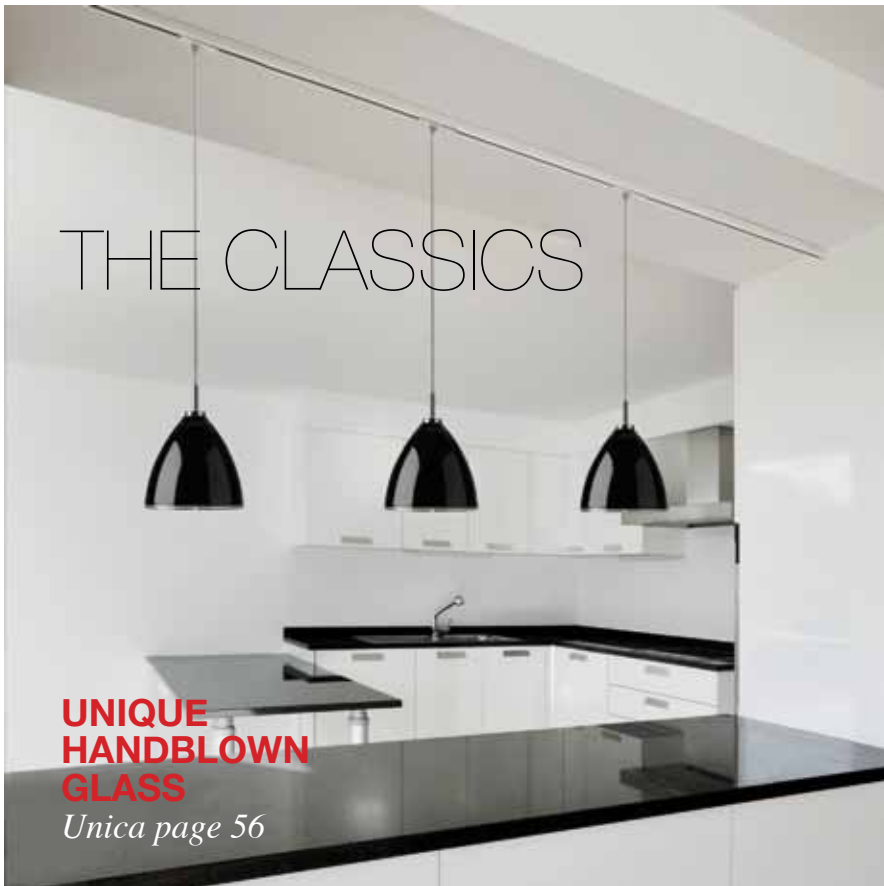

WE HELP
YOU DESIGN
YOUR
RAIL
SYSTEM



MAGNETIC
LIGHT
12V

- designed for everyday life

MAGNETIC FLEXIBILITY

Magnetline by Scan Studio Lighting





EASILY CLICK YOUR LIGHTING ON AND OFF – MAGNETLINE AND MICROLINE SYSTEMS

MAGNETIC AND FLEXIBLE SOLUTION

MAGNETLINE IS THE MOST EXPANDED MODULE IN OUR RANGE. IT FITS ALL INTERIORS (INCLUDING MOISTY ROOMS). A LOT OF DIFFERENT PENDANTS AND SPOTS TO CHOOSE FROM; AS LONG AS IT FITS THE 12V SYSTEM. GET INSPIRED ON THE FOLLOWING PAGES.

THE MAGNETIC MICROLINE SYSTEM

FOR SMALLER AREAS; LIKE GLASS DISPLAY CABINETS; WE OFFER THE MICROLINE SOLUTION. IT IS SIMILAR TO THE MAGNETLINE, JUST SMALLER! ONLY TINY SPOTS FIT THIS SYSTEM.

SP O TS

LED AND HALOGEN SPOTS 12V

The spots are designed by
Scan Studio Lighting.

Contact us for further details.

Scan Studio Lighting ApS
Tel.: +45 63 41 88 88
l@scanstudio.dk
www.scanstudiolighting.dk





SPOTS ARE ON



Mac I LED Magnet

for Magnetline

Dimensions: 180 x 150 mm

Energy efficiency category: A

6 W, 2800° K, 354 Lumen

Art.-No. version

2-224-01-3 chrome

2-224-01-9 silver matt

Mac II LED Magnet

for Magnetline

Dimensions: 380 x 160 mm

Energy efficiency category: A

2 x 6 W, 2800° K, 2 x 358 Lumen

Art.-No. version

2-224-00-3 chrome

2-224-00-9 silver matt

Transformer

Halogen 60 W / LED 48 W (see fig. A)

Art.-No. version

6-610-12-3 chrome

6-610-12-9 silver matt

Halogen 150 W / LED 120 W (see fig. B)

Art.-No. version

6-610-13-3 chrome

6-610-13-9 silver matt



A



B



MAGNETIC AND FLEXIBLE



Ledion 6 W LED Magnet (see fig. A)

for Magnetline

Height: 120 mm

6 W, 2800° K, 267 Lumen

Art.-No. version

2-224-02-3 chrome

2-224-02-9 silver matt

Eta LED Magnet (see fig. B)

for Magnetline

Height: 120 mm

Energy efficiency category: A

3 W, 3000°/2700° K, 180 Lumen

Art.-No. version

2-232-02-3 chrome

2-232-02-9 silver matt

Spot Magnet LED Basic (see fig. C)

for Magnetline

2 Optics included 10° and 18°

Dimensions: 80 x 60 mm

Art.-No. version

2-220-02-3 chrome

Transformer

Halogen 60 W / LED 48 W (see fig. D)

Art.-No. version

6-610-12-3 chrome

6-610-12-9 silver matt

Halogen 150 W / LED 120 W (see fig. E)

Art.-No. version

6-610-13-3 chrome

6-610-13-9 silver matt



ROOM LIGHT WITH NEW DESIGN



Ledion 7 W LED Magnet (see fig. A)

for Magnetline, **DIMMABLE**

Height: 120 mm

Energy efficiency category: A

7 W, 2800° K, 267 Lumen

Art.-No. version

2-224-02-3 chrome

2-224-02-9 silver matt

Mercur LED Magnet (see fig. B)

for Magnetline, **DIMMABLE**

Height: 70 mm, Socket: GU5,3

Energy efficiency category: A

7 W, 3000° K, 410 Lumen

Art.-No. version

2-227-03-3 chrome

2-227-03-9 silver mat

Polo LED Magnet (see fig. C)

for Magnetline, **DIMMABLE**

Height: 185 mm, Socket: GU5,3

Energy efficiency category: A

7 W, 3000° K, 410 Lumen

Art.-No. version

2-227-04-3 chrome

2-227-04-9 silver matt

Transformer Magnet 105 W

track max. 2 m, **DIMMABLE** (see fig. D)

Art.-No. version

6-610-10-3 chrome

6-610-10-9 silver matt

Transformer Magnet 150 W

track max. 2 m, **DIMMABLE** (see fig. E)

Art.-No. version

6-610-11-3 chrome

6-610-11-9 silver matt

other LED transformers see page 22



ROOM LIGHTING WITH DESIGN



Edge LED Magnet

for Magnetline.

Soft stylish room light

Height max.: 280 mm

Energy efficiency category: A

4 W, 2800° K, 224 Lumen

Art.-No. version

2-232-03-1 white

2-232-03-3 chrome

2-232-03-9 silver matt

Transformer

Halogen 60 W / LED 48 W (see fig. A)

Art.-No. version

6-610-12-3 chrome

6-610-12-9 silver matt

Halogen 150 W / LED 120 W (see fig. B)

Art.-No. version

6-610-13-3 chrome

6-610-13-9 silver matt

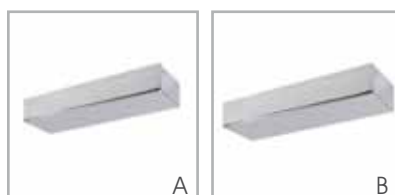



HOT AND GOLD



Spot Naples LED

for Magnetline.

Height of glass: 90 mm

Diameter of glass: Ø 70 mm

Energy efficiency category: A

5 W, 2800° K, 276 Lumen

Art.-No.	version
2-229-01-3	white / chrome
2-229-02-3	black / chrome
2-229-03-3	chrome / chrome

2-229-01-9	white / silver matt
2-229-02-9	black / silver matt

Transformer

Halogen 60 W / LED 48 W (see fig. A)

Art.-No.	version
6-610-12-3	chrome
6-610-12-9	silver matt

Halogen 150 W / LED 120 W (see fig. B)

Art.-No.	version
6-610-13-3	chrome
6-610-13-9	silver matt



A



B



HAND BLOWN GLASS



Spot Unica Mini LED

for Magnetline.

Made of hand-blown glass.

Each glass is unique and signed by the glass artist.

Available in several colours, call us for more info.

Height of glass: 110 mm

Diameter of glass: Ø 100 mm

Energy efficiency category: A

5 W, 2800° K, 276 Lumen

Art.-No. version

2-227-01-3 white / chrome

2-227-01-9 white / silver

2-227-02-3 black / chrome

2-227-02-9 black / silver

Transformer

Halogen 60 W / LED 48 W (see fig. A)

Art.-No. version

6-610-12-3 chrome

6-610-12-9 silver matt

Halogen 150 W / LED 120 W (see fig. B)

Art.-No. version

6-610-13-3 chrome

6-610-13-9 silver matt



A



B



CHOOSE YOUR UNIQUE COLOUR



Spot Mini Queen

for Magnetline.

Made of hand-blown glass.

Each glass is unique and signed by the glass artist.

Height of glass: 60 mm

Diameter of glass: Ø 80 mm

Energy efficiency category: B - D

Socket: GY6,35 max. 12 V/50 W

Art.-No.	version
2-221-71-3	white / chrome
2-221-72-3	black / chrome
2-221-73-3	green / chrome
2-221-71-9	white / silver matt
2-221-72-9	black / silver matt
2-221-73-9	green / silver matt



HAND BLOWN GLASS



Spot Unica Mini

for Magnetline.

Made of hand-blown glass.

Each glass is unique and signed
by the glass artist.

Height of glass: 110 mm

Diameter of glass: Ø 100 mm

Energy efficiency category: B - D

Socket: GY6,35 max. 12 V/50 W

Art.-No. version

2-274-04-1-3 white / chrome

2-274-04-2-3 black / chrome

2-274-04-1-9 white / silver matt

2-274-04-2-9 black / silver matt



SPOT ON EVERYDAY LIFE



chrome



silver matt



Spot Eleven Magnet

for Magnetline

Dimensions: 360 x 100 mm

Energy efficiency category: A⁺- D

Socket: 2 x G 53 max. 12 V/35 W
for AR 111

Art.-No.	version
2-225-25-3	chrome
2-225-25-9	silver matt



MAGNETIC AND FLEXIBLE



Eta Magnet

for Magnetline

Height: 70 mm

Energy efficiency category: A⁺- D

Socket: GU5,3 max. 12 V/50 W

Art.-No.	version
2-221-12-3	chrome
2-221-12-9	silver matt

Magnet Basic

for Microline and Magnetline

Dimensions: 110 x 160 mm

Energy efficiency category: A⁺- D

Socket: GY6,35 max. 12 V/3 5W

Art.-No.	version
2-220-01-3	chrome
2-220-01-9	silver matt



TURN MY HEAD



Polo Magnet

for Magnetline

Height: 185 mm

Energy efficiency category: A⁺- D

Socket: GU5,3 max. 12 V/50 W Alu

Art.-No. **version**

2-221-40-3 chrome

2-221-40-9 silver matt

Spot Cool Magnet

for Magnetline

Crystal glass

Dimensions: 50 x 50 x 50 mm

Energy efficiency category: A⁺- D

Socket: G4 max. 12 V/ 20W

Art.-No. **version**

2-221-33-3 clear / chrome

2-221-33-9 clear / silver matt



SPOT LIGHT ARE ON



Spot Mini Focus Magnet

for Magnetline

Height of glass: 65 mm

Diameter of glass: Ø 60 mm

Energy efficiency category: B - D

Socket: GY6,35 max. 12 V/50 W

Art.-No.	version
----------	---------

2-221-11-3	white / chrome
------------	----------------

2-221-11-9	white / silver matt
------------	---------------------

Malou Magnet

for Magnetline

Height: 130 mm, Diameter: Ø 60 mm

Energy efficiency category: A⁺- D

Socket: GU5,3 max. 12 V/35 W

Art.-No.	version
----------	---------

2-221-01-3	white / chrome
------------	----------------

2-221-01-9	white / silver matt
------------	---------------------





PEN DAN TS

LED AND HALOGEN PENDANTS 12V THREE POSSIBILITIES

All pendants are adaptable on three different mounting designs.



Magnet adapter for the Magnetline system



Decorative transformer Halogen for surface mounted lamps



Decorative transformer LED for surface mounted lamps



Mounting plate for suspended ceilings

The metal Parts are available in a chrome or silver matt surface.

Contact us for further details.

Scan Studio Lighting ApS
Tel.: +45 63 41 88 88
l@scanstudio.dk
www.scanstudiolighting.dk





THE SHAPE OF AN EGG



Pendant Drop LED

Adaptable to Magnet adapter, plate for installation through ceiling cut out, Decotrafo.

Height: 150 mm
Diameter: Ø 115 mm
Energy efficiency category: A

6 W, 2800°K, 350 Lumen

Art.-No.	version
2-224-06-3	chrome

Transformer

Halogen 60 W / LED 48 W (see fig. A)

Art.-No.	version
6-610-12-3	chrome
6-610-12-9	silver matt

Halogen 150 W / LED 120 W (see fig. B)

Art.-No.	version
6-610-13-3	chrome
6-610-13-9	silver matt

Deco-Trafo LED 9 W (see fig. C)

Art.-No.	version
6-607-09-3	chrome
6-607-09-9	silver matt



A



B



C



INSPIRED BY HEAD LIGHTS



Pendant Eye LED

Adaptable to Magnet adapter, plate for installation through ceiling cut out, Decotrafo.

Available in several colours, call us for more info.

Height: 230 mm

Diameter: Ø 120 mm

Energy efficiency category: A

6 W, 2800° K, 276 Lumen

Art.-No. version

2-224-05-2 black

2-224-05-3 chrome

Transformer

Halogen 60 W / LED 48 W (see fig. A)

Art.-No. version

6-610-12-3 chrome

6-610-12-9 silver matt

Halogen 150 W / LED 120 W (see fig. B)

Art.-No. version

6-610-13-3 chrome

6-610-13-9 silver matt

Deco-Trafo LED 9 W (see fig. C)

Art.-No. version

6-607-09-3 chrome

6-607-09-9 silver matt





FEELS LIKE MUSIC



Pendant Tube LED

Adaptable to Magnet adapter, plate for installation through ceiling cut out, Decotrafo.

Height: 410 mm
Diameter: Ø 40 mm
Energy efficiency category: A

3 W, 3000° K, 122 Lumen

Art.-No.	version
2-224-04-2	black
2-224-04-3	chrome
2-224-04-9	silver matt

Transformer

Halogen 60 W / LED 48 W (see fig. A)

Art.-No.	version
6-610-12-3	chrome
6-610-12-9	silver matt

Halogen 150 W / LED 120 W (see fig. B)

Art.-No.	version
6-610-13-3	chrome
6-610-13-9	silver matt

Deco-Trafo LED 9 W (see fig. C)

Art.-No.	version
6-607-09-3	chrome
6-607-09-9	silver matt



A



B



C





**UNIQUE
HANDBLOWN
GLASS**

**EACH PIECE IS UNIQUE AND MADE BY A GLASS ARTIST IN DENMARK.
CONTACT US FOR YOUR SPECIFIC COLOUR NEEDS.**



TRANSPARENT GLASS LIGHTING



Pendant Unica Single LED

Adaptable to Magnet adapter, plate for installation through ceiling cut out, Decotrafo.

Made of hand-blown glass.
Each glass is unique and signed by the glass artist.
Available in several colours, call us for more info.

Height of glass: ca. 150 mm
Diameter of glass: Ø ca. 150 mm
Energy efficiency category: A

5 W, 2800°K, 276 Lumen

Art.-No.	version
2-234-01-3	white / chrome
2-234-02-3	black / chrome

2-234-01-9	white / silver matt
2-234-02-9	black / silver matt

Transformer

Halogen 60 W / LED 48 W (see fig. A)

Art.-No.	version
6-610-12-3	chrome
6-610-12-9	silver matt

Halogen 150 W / LED 120 W (see fig. B)

Art.-No.	version
6-610-13-3	chrome
6-610-13-9	silver matt

Deco-Trafo LED 9 W (see fig. C)

Art.-No.	version
6-607-09-3	chrome
6-607-09-9	silver matt





GLASS LIGHTING



Pendant Unica Mini Single LED

Adaptable to Magnet adapter, plate for installation through ceiling cut out, Decotrafo.

Made of hand-blown glass.
Each glass is unique and signed by the glass artist.
Available in several colours, call us for more info.

Height of glass: ca. 110 mm
Diameter of glass: Ø ca. 100 mm
Energy efficiency category: A

5 W, 2800° K, 276 Lumen

Art.-No.	version
2-230-01-3	white / chrome
2-230-02-3	black / chrome

2-230-01-9	white / silver matt
2-230-02-9	black / silver matt

Transformer

Halogen 60 W / LED 48 W (see fig. A)

Art.-No.	version
6-610-12-3	chrome
6-610-12-9	silver matt

Halogen 150 W / LED 120 W (see fig. B)

Art.-No.	version
6-610-13-3	chrome
6-610-13-9	silver matt

Deco-Trafo LED 9 W (see fig. C)

Art.-No.	version
6-607-09-3	chrome
6-607-09-9	silver matt





TRANSPARENT AND GLASS LIGHTING



Pendant Queen 160 LED

Adaptable to Magnet adapter, plate for installation through ceiling cut out, Decotrafo.

Made of hand-blown glass.
Each glass is unique and signed by the glass artist.
Available in several colours, call us for more info.

Height of glass: ca. 160 mm
Diameter of glass: Ø ca. 160 mm
Energy efficiency category: A

6 W, 2800°K, 341 Lumen

Art.-No.	version
2-227-07-3	white / chrome
2-227-07-2	white / black
2-227-07-9	white / silver matt

2-227-08-3	black / chrome
2-227-08-2	black / black
2-227-08-9	black / silver matt

Transformer

Halogen 60 W / LED 48 W (see fig. A)

Art.-No.	version
6-610-12-3	chrome
6-610-12-9	silver matt

Halogen 150 W / LED 120 W (see fig. B)

Art.-No.	version
6-610-13-3	chrome
6-610-13-9	silver matt

Deco-Trafo LED 9 W (see fig. C)

Art.-No.	version
6-607-09-3	chrome
6-607-09-9	silver matt





GLASS LIGHTING



Pendant Queen LED

Adaptable to Magnet adapter, plate for installation through ceiling cut out, Decotrafo.



Made of hand-blown glass.
Each glass is unique and signed by the glass artist.
Available in several colours, call us for more info.

Height of glass: ca. 135 mm
Diameter of glass: Ø ca. 120 mm
Energy efficiency category: A

5 W, 2800°K, 276 Lumen

Art.-No.	version
2-227-05-3	white / chrome
2-227-05-9	white / silver matt

2-227-06-3	black / chrome
2-227-06-9	black / silver matt

Transformer

Halogen 60 W / LED 48 W (see fig. A)

Art.-No.	version
6-610-12-3	chrome
6-610-12-9	silver matt

Halogen 150 W / LED 120 W (see fig. B)

Art.-No.	version
6-610-13-3	chrome
6-610-13-9	silver matt

Deco-Trafo LED 9 W (see fig. C)

Art.-No.	version
6-607-09-3	chrome
6-607-09-9	silver matt



A



B



C



CLEAN AND CLASSIC MEDIUM



Pendant Unica Single

Adaptable to Magnet adapter, plate for installation through ceiling cut out, Decotrafo.

Made of hand-blown glass.
Each glass is unique and signed by the glass artist.
Available in several colours, call for more info.

Height of glass: ca. 150 mm
Diameter of glass: Ø ca. 150 mm
Energy efficiency category: B - D
Socket: GY6,35 max. 12 V/50 W

Art.-No.	version
2-271-01-3	white / chrome
2-271-02-3	black / chrome

2-271-01-9	white / silver matt
2-271-02-9	black / silver matt

CLEAN AND CLASSIC MINI



Pendant Unica Mini

Adaptable to Magnet adapter, plate for installation through ceiling cut out, Decotrafo.

Made of hand-blown glass.
Each glass is unique and signed by the glass artist.
Available in several colours, call for more info.

Height of glass: ca. 110 mm
Diameter of glass: Ø ca. 100 mm
Energy efficiency category: B - D
Socket: GY6,35 max. 12V/50 W

Art.-No.	version
2-274-1-3	white / chrome
2-274-2-3	black / chrome

2-274-1-9	white / silver matt
2-274-2-9	black / silver matt



TRANSPARENT AND GLASS LIGHTING



Pendant Queen

Adaptable to Magnet adapter, plate for installation through ceiling cut out, Decotrafo.

Made of hand-blown glass.
Each glass is unique and signed by the glass artist.
Height of glass: ca. 135 mm
Diameter of glass: Ø ca. 120 mm
Energy efficiency category: B - D
Socket: GY6,35 max. 12 V/50 W

Art.-No.	version
2-275-01-3	white / chrome
2-275-02-3	black / chrome

2-275-01-9	white / silver matt
2-275-02-9	black / silver matt





HOT AND GOLD



Pendant Naples LED

Adaptable to Magnet adapter, plate for installation through ceiling cut out, Decotrafo.

Height of glass: 90 mm
Diameter of glass: Ø 70 mm
Energy efficiency category: A

5 W, 2800°K, 276 Lumen

Art.-No.	version
2-228-01-3	white / chrome
2-228-01-9	white/ siver matt

2-228-02-3	black / chrome
2-228-02-9	black/ siver matt

2-228-03-3	chrome / chrome
------------	-----------------

Transformer

Halogen 60 W / LED 48 W (see fig. A)

Art.-No.	version
6-610-12-3	chrome
6-610-12-9	silver matt

Halogen 150 W / LED 120 W (see fig. B)

Art.-No.	version
6-610-13-3	chrome
6-610-13-9	silver matt

Deco-Trafo LED 9 W (see fig. C)

Art.-No.	version
6-607-09-3	chrome
6-607-09-9	silver matt



A



B



C



BEAUTIFUL CLASSIC COTTON AND LEATHER



Pendant Ceres Single

Adaptable to Magnet adapter, plate for installation through ceiling cut out, Decotrafo.

Height: 100 mm
Diameter: Ø 125mm
Energy efficiency category: A

6 W, 2800°K, 341 Lumen

Art.-No.	version
2-231-01-3	white / chrome
2-231-01-9	white / silver matt

2-231-02-3	black / chrome
2-231-02-9	black / silver matt

Transformer

Halogen 60 W / LED 48 W (see fig. A)

Art.-No.	version
6-610-12-3	chrome
6-610-12-9	silver matt

Halogen 150 W / LED 120 W (see fig. B)

Art.-No.	version
6-610-13-3	chrome
6-610-13-9	silver matt

Deco-Trafo LED 9 W (see fig. C)

Art.-No.	version
6-607-09-3	chrome
6-607-09-9	silver matt



NATURAL LIGHT



Pendant Focus Single

Adaptable to Magnet adapter,
plate for installation through ceiling
cut out, Decotrafo.

Height of glass: 60 mm

Diameter of glass: Ø 170 mm

Energy efficiency category: B - D

Socket: GY6,35 max. 12 V/50 W

Art.-No.	version
----------	---------

2-289-11-3	white / chrome
------------	----------------

2-289-11-9	white / silver matt
------------	---------------------



MATT BEAUTIFUL GLASS



Pendant Venus LED

Adaptable to Magnet adapter, plate for installation through ceiling cut out, Decotrafo.

Diameter of glass: Ø 160 mm
Height of glass: 80 mm
Energy efficiency category: A

6 W, 2800°K, 341 Lumen

Art.-No.	version
2-233-01-3	white / chrome
2-233-01-9	white / silver matt

Transformer

Halogen 60 W / LED 48 W (see fig. A)

Art.-No.	version
6-610-12-3	chrome
6-610-12-9	silver matt

Halogen 150 W / LED 120 W (see fig. B)

Art.-No.	version
6-610-13-3	chrome
6-610-13-9	silver matt

Deco-Trafo LED 9 W (see fig. C)

Art.-No.	version
6-607-09-3	chrome
6-607-09-9	silver matt





MATT BEAUTIFUL GLASS



Pendant Miami Single

Adaptable to Magnet adapter,
plate for installation through ceiling
cut out, Decotrafo.

Height of glass: 180 mm

Diameter of glass: Ø 90 mm

Energy efficiency category: B - D

Socket: GY6,35 max. 12 V/50 W

Art.-No.

version

2-772-01-3 white / chrome

2-772-01-9 white / silver matt





ACCESSORIES



New Magnet adapter
for pendant - easy to mount
available from June.

Art.-No.	version
4-424-20-3	chrome / black
4-424-20-9	silver matt / grey



Middle power feed

Art.-No.	version
4-424-40-3	chrome
4-424-40-9	silver matt

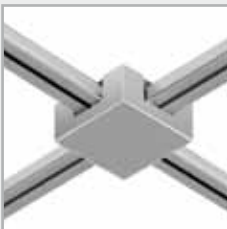

Uni-Connector
conductive

Art.-No.	version
4-424-83-3	chrome
4-424-83-9	silver matt



T-Connector/ Power feed
conductive

Art.-No.	version
4-424-60-3	chrome
4-424-60-9	silver matt



Flex-Connector
vertical, conductive

Art.-No.	version
4-424-81-3	chrome
4-424-81-9	silver matt



Magnetline track

Art.-No.	version
3-307-10-3	chrome 100 cm
3-307-15-3	chrome 150 cm
3-307-20-3	chrome 200 cm
3-307-10-9	silver matt 100 cm
3-307-15-9	silver matt 150 cm
3-307-20-9	silver matt 200 cm



Connector
straight / conductive

Art.-No.	version
4-424-45-3	chrome
4-424-45-9	silver matt



Flex-Connector
horizontal, conductive

Art.-No.	version
4-424-80-3	chrome
4-424-80-9	silver matt



Wire suspension
Length 2 m. Set with 2 pcs.
Suspensions without mounting
bracket.

Art.-No.	version
4-424-15-3	chrome
4-424-15-9	silver matt

ACCESSORIES



Mounting bracket standard
Art.-No. **version**
 4-424-02-3 chrome / black
 4-424-02-9 silver matt / grey



Mounting bracket luxury
Art.-No. **version**
 4-424-06-3 chrome
 4-424-06-9 silver matt



Kit - Mounting bracket standard
 consisting of following parts:
 • 2 brackets and accessories
 • 2 end caps, one for power feed
Art.-No. **version**
 4-424-05-3 chrome / black
 4-424-05-9 silver matt / grey



Kit - Mounting bracket luxury
 consisting of following parts:
 • 2 brackets and accessories
 • 2 end caps, one for power feed
Art.-No. **version**
 4-424-07-3 chrome
 4-424-07-9 silver matt



Suspension standard
 Length: 120 mm
Art.-No. **version**
 4-424-00-3 chrome / black
 4-424-00-9 silver matt / grey



Suspension standard turning and pivoting
 Length: 65 mm
Art.-No. **version**
 4-424-01-3 chrome / black
 4-424-01-9 silver matt / grey



End cap standard for power feed
Art.-No. **version**
 4-424-31-2 black
 4-424-31-9 grey



End cap standard
Art.-No. **version**
 4-424-30-2 black
 4-424-30-9 grey



End cap luxury for power feed
Art.-No. **version**
 4-424-33-3 chrome
 4-424-33-9 silver matt



End cap luxury
Art.-No. **version**
 4-424-32-3 chrome
 4-424-32-9 silver matt



Mounting plate
for pendants or spots,
for installation through ceiling
cut out

Art.-No.	version
4-400-04-3	chrome / black
4-400-04-9	silver matt / grey



Mounting bracket for pendants

Art.-No.	version
4-412-00-3	chrome



Deco-Trafo 105 W
for pendants

Art.-No.	version
6-605-10-3	chrome
6-605-10-9	silver matt



Deco-Trafo 9 W LED
for pendants

Art.-No.	version
6-607-09-3	chrome
6-607-09-9	silver matt



Transformer Magnet 150 W
for Magnetline

Art.-No.	version
6-610-11-3	chrome
6-610-11-9	silver matt



Transformer Magnet 105 W
for Magnetline

Art.-No.	version
6-610-10-3	chrome
6-610-10-9	silver matt
6-615-10-3	chrome (Touch)
6-615-10-9	silver matt (Touch)



Transformer Halogen 60 W / LED 48 W
for Magnetline

Art.-No.	version
6-610-12-3	chrome
6-610-12-9	silver matt



Transformer Halogen 150 W / LED 120 W
for Magnetline

Art.-No.	version
6-610-13-3	chrome
6-610-13-9	silver matt



Transformer Halogen 200 W / LED 100 W

Art.-No.	version
6-680-20-1	

KITS TO GO

Order your kit today - all set to go.

Scan Studio Lighting ApS
Tel.: +45 63 41 88 88
l@scanstudio.dk
www.scanstudiolighting.dk

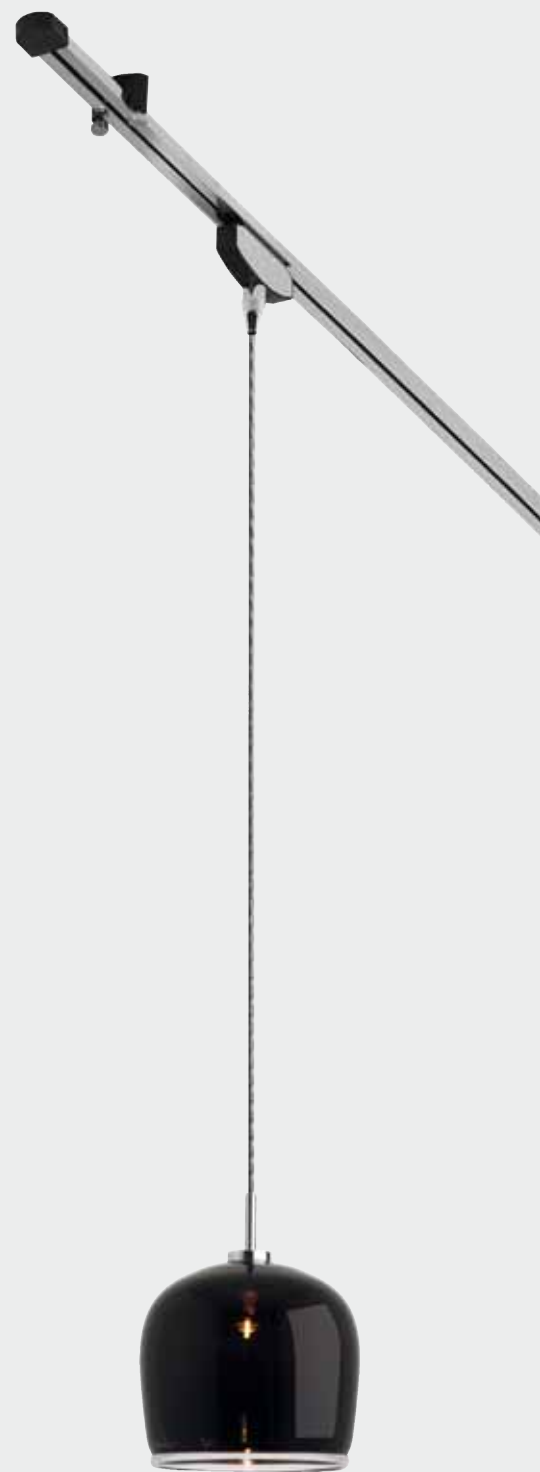

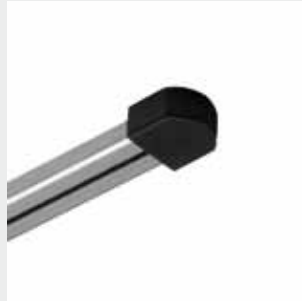

Magnetline Kits

Consists of the following parts:

- Track 150 cm
- 2 end caps
- 2 brackets
- Transformer Magnet or LED Converter
- lamps (see Kit description)
- lamp bulbs



KITS ALL SET TO GO ...

Kit Queen

Art.-No. **version**
1-276-01-3 white / chrome
1-276-02-3 black / chrome



Kit Unica

Art.-No. **version**
1-271-01-3 white / chrome
1-271-02-3 black / chrome



Kit Focus





Kit Eta LED Magnet

4 x 3 Watt

Art.-No.	version
1-506-12-3-3	chrome
1-506-12-9-9	silver matt



Kit Ledion LED Magnet

3 x 6 Watt

Art.-No.	version
1-224-02-3	chrome
1-224-02-9	silver matt



Kit Ledion LED Magnet

3 x 7 Watt, **dimmable**

Art.-No.	version
1-224-03-3	chrome
1-224-03-9	silver matt



Kit Eleven Magnet

Art.-No.	version
1-225-25-3	chrome
1-225-25-9	silver matt

KITS ALL SET TO GO ...

Kit Mini Queen Magnet

Art.-No.	version
1-221-71-3	white / chrome
1-221-72-3	black / chrome
1-221-71-9	white / silver matt
1-221-72-9	black / silver matt



Kit Unica Mini Magnet

Art.-No.	version
1-274-1-3	white / chrome
1-274-2-3	black / chrome
1-274-1-9	white / silver matt
1-274-2-9	black / silver matt



Kit Mac I

Art.-No.	version
1-224-01-3	chrome
1-224-01-9	silver matt



Kit Mac II

Art.-No.	version
1-224-00-3	chrome
1-224-00-9	silver matt



Kit Eta Magnet

Art.-No.	version
1-506-12-3	chrome
1-506-12-9	silver matt





Kit Polo Magnet

Art.-No.	version
1-506-40-3	chrome
1-506-40-9	silver matt



Kit Cool Magnet

Art.-No.	version
1-506-33-3	clear / chrome
1-506-33-9	clear / silver matt



Kit Malou Magnet

Art.-No.	version
1-506-21-01-3	white / chrome
1-506-21-01-9	white / silver matt

MICRO RO LINE



Spot Magnet Basic

for Microline and Magnetline
Socket: GY6,35 max. 12 V/35W
Energy efficiency category: B - D
Dimensions: 110 x 160 mm

Art.-No.	version
2-220-01-3	chrome
2-220-01-9	silver matt

Spot Magnet LED Basic

for Microline, 1 Watt.
2 Optics included 10° and 18°
Dimensions: 80 x 60 mm
Energy efficiency category: A

Art.-No.	version
2-220-02-3	chrome

Microline system

Microline track (see fig. A)

Art.-No.	version
3-308-10-3	chrome 1 m
3-308-15-3	chrome 1,5 m
3-308-20-3	chrome 2 m
3-308-10-9	silver matt 1 m
3-308-15-9	silver matt 1,5 m
3-308-20-9	silver matt 2 m

Microline mounting bracket (see fig. B)

Length: 6 mm

Art.-No.	version
4-425-10-3	chrome / transparent
4-425-10-9	silver / transparent

Microline suspension (see fig. C)
turning and pivoting, length: 65 mm

Art.-No.	version
4-424-90-3	chrome / transparent
4-424-90-9	silver / transparent

LED-Converter 1-30 W (see fig. D)

Art.-No.	6-680-03-1
----------	------------







SET YOUR SCENE

Flexible lighting in your home



Scan Studio® Lighting

PROLINE
SYSTEM
230V

- designed for everyday life



Electric power, 230V, the standard system for most homes.

No Transformer is needed, but you have to turn off all electric power, whenever you wish to change your lighting in the rail system.

This rail system comes in 3 colours: Black, silver and white.

The rails can be angled in 90 degrees and only on regular surfaces.

Contact us for your specific measurements, and we will help you design your rail system.

Scan Studio Lighting ApS
Tel.: +45 63 41 88 88
l@scanstudio.dk
www.scanstudiolighting.dk



PROLINE

Rail sytem Proline 230V



- *No Transformer needed.*
- *Rail system available in three colours:
Black, white and silver.*

PEN DAN TS

Contact us for further details.

Scan Studio Lighting ApS
Tel.: +45 63 41 88 88
l@scanstudio.dk
www.scanstudiolighting.dk







NEW
COLOURS
AND SHAPES

EACH PENDANT GIVES A BEAUTIFUL LIGHT.
MADE FOR THE PROLINE SYSTEM BY SCAN STUDIO LIGHTING



THE NEW LOOK



Pendant Saturn

Included canopy, adaptable for Proline system 230V.

Height: 270 mm

Diameter: Ø 280 mm

Energy efficiency category: A⁺ - D

Socket: E27 max. 75 W

Art.-No.	version
2-279-02-1	white/gold



NEW NORDIC STYLE



Pendant Zaron

Included canopy, adaptable for Proline system 230V.

Height: 230 mm

Diameter: Ø 280 mm

Energy efficiency category: A⁺ - D

Socket: E27 max. 75 W

Art.-No.

version

2-279-03-2 black / red cable

2-279-03-6 copper

RETRO COLOURS



Pendant Lavoro

Included canopy, adaptable for Proline system 230V.
Available in several colours, call us for more info.

Height: 200 mm
Diameter: Ø 370 mm
Energy efficiency category: A⁺ - D
Socket: E27 max. 75 W

Art.-No.	version
2-279-04-1	white
2-279-04-2	black
2-279-04-6	cooper





HAND BLOWN GLASS



Pendant Unica Proline

for Proline system 230V.

Made of hand-blown glass.

Each glass is unique and signed by the glass artist.

Available in several colours, call us for more info.

Height of glass: ca. 150 mm

Diameter of glass: Ø ca. 150 mm

Energy efficiency category: A⁺ - D

Socket: G9 max. 35 W

Art.-No.	version
2-251-01-3	white / chrome
2-251-02-3	black / chrome



DANISH DESIGN



Pendant Unica Mini Proline

for Proline system 230V.

Made of hand-blown glass.

Each glass is unique and signed by the glass artist.

Available in several colours, call us for more info.

Height of glass: ca. 110 mm

Diameter of glass: Ø ca. 100 mm

Energy efficiency category: A⁺ - D

Socket: G9 max. 35 W

Art.-No.	version
2-252-01-3	white / chrome
2-252-02-3	black / chrome



HAND BLOWN GLASS



Pendant Queen Proline

for Proline system 230V.

Made of hand-blown glass.

Each glass is unique and signed by the glass artist.

Available in several colours, call us for more info.

Height of glass: ca. 135 mm

Diameter of glass: Ø ca. 120 mm

Energy efficiency category: A⁺ - D

Socket: G9 max. 35 W

Art.-No.	version
----------	---------

2-256-01-3	white / chrome
------------	----------------

2-256-02-3	black / chrome
------------	----------------



CLEAN AND CLASSIC



Pendant Miami Proline
for Proline system 230V.

Height of glass: 180 mm
Diameter of glass: Ø 90 mm
Energy efficiency category: A⁺ - D
Socket: G9 max. 35 W

Art.-No.	version
2-254-01-3	white / chrome



SP

O

TS

Contact us for further details.

Scan Studio Lighting ApS
Tel.: +45 63 41 88 88
l@scanstudio.dk
www.scanstudiolighting.dk





**PUT YOUR LIFE
IN THE SPOT**

HAND BLOWN GLASS



Spot Unica Mini Proline

for Proline system 230V.

Made of hand-blown glass.
Each glass is unique and signed
by the glass artist.

Height of glass: 110 mm
Diameter of glass: Ø 100 mm
Energy efficiency category: A⁺ - D
Socket: G9 max. 35 W

Art.-No.	version
2-252-01-3	white / chrom
2-252-02-3	black / chrom



... AND DANISH DESIGN



Spot Mini Queen Proline

for Proline system 230V.

Made of hand-blown glass.

Each glass is unique and signed
by the glass artist.

Height of glass: 60 mm

Diameter of glass: Ø 80 mm

Energy efficiency category: A⁺ - D

Socket: G9 max. 35 W

Art.-No.

2-253-01-3

2-253-02-3

version

white /chrom

black /chrom



SPOTS ARE ON



Spot Eta Proline

for Proline system 230V

Energy efficiency category: A⁺ - D

Socket: GU10

LED or Halogen max. 35 W

Art.-No.	version
2-250-00-1	white
2-250-00-9	silver

Spot Ledion Proline

for Proline system 230V

Energy efficiency category: A⁺ - D

Socket: GU10

LED or Halogen max. 35 W

Art.-No.	version
2-250-01-1	white
2-250-01-9	silver



ACCESSORIES



Proline track 100 cm

Art.-No.	version
3-310-10-1	white
3-310-10-2	black
3-310-10-9	silver



Proline track 200 cm

Art.-No.	version
3-310-20-1	white
3-310-20-2	black
3-310-20-9	silver



Power feed
for Proline system

Art.-No.	version
4-410-02-1	white
4-410-02-2	black
4-410-02-9	silver



Adapter 230V
for Proline system

Art.-No.	version
4-410-01-1	white
4-410-01-2	black
4-410-01-9	silver



Ceiling clamp

for Proline system

Art.-No.	version
4-410-04-1	white
4-410-04-2	black
4-410-04-9	silver



Connector

for Proline system

Art.-No.	version
4-410-05-1	white
4-410-05-2	black
4-410-05-9	silver



End cap

for Proline system

Art.-No.	version
4-410-03-1	white
4-410-03-2	black
4-410-03-9	silver



L-connector

for Proline system

Art.-No.	version
4-410-06-1	white
4-410-06-2	black
4-410-06-9	silver



Flexible light in your home

SET YOUR SCENE

OTHER
LIGHTING
PRODUCTS

230V lighting

CEILING & WALL L L

Contact us for further details.

Scan Studio Lighting ApS
Tel.: +45 63 41 88 88
l@scanstudio.dk
www.scanstudiolighting.dk





NEW DOWNLIGHT



LED Downlight EASY white

Recessed luminaires, adjustable.
Dimmable incl. Converter.

Diameter: Ø 100 mm
Height: 60 mm
Ceiling cutout: Ø 90 mm
Energy efficiency category: A

10 W, 2700°K, 626 Lumen

Art.-No.
2-215-04-1

LED Downlight EASY

Build on ceiling /wall
Dimmable incl. Converter
Build on adjustable luminaires

Diameter: Ø 100 mm
Height: 105 mm
Energy efficiency category: A

10 W, 2700°K, 626 Lumen

Art.-No.
2-215-05-1



LED DOWNLIGHT ALU



LED Downlight RA 9

Recessed luminaires, adjustable.
Downlight Alu with 6.6 Bridgelux LED
incl. Converter.

Diameter: Ø 92 mm
Ceiling cutout: Ø 80 mm
Recessed depth: 90 mm
Energy efficiency category: A

6,6 W, 3000°K

Art.-No.
2-510-01-9

LED Downlight SQ 9

Recessed luminaires, adjustable.
Downlight Alu with 6.6 Bridgelux LED
incl. Converter.

Dimensions: 100 x 100 mm
Ceiling cutout: 85 x 85 mm
Recessed depth: 110 mm
Energy efficiency category: A

6,6 W, 3000°K

6,6 W, 3000°K

Art.-No.
2-510-02-9



LED DOWNLIGHT WHITE



LED Downlight RW 1

Recessed luminaires, adjustable.
Downlight white with 6.6 Bridgelux LED
incl. Converter.

Diameter: Ø 105 mm
Ceiling cutout: Ø 98 mm
Recessed depth: 78 mm
Energy efficiency category: A

6,6 W, 3000°K, 427 Lumen

Art.-No.
2-510-01-1

LED Downlight QI

Recessed luminaires, adjustable.
incl. Converter - Dimmable.

Diameter: Ø 90 mm
Ceiling cutout: Ø 75 mm
Recessed depth: 33 mm
Energy efficiency category: A

6 W, 3000°K, 270 Lumen

Art.-No.
2-620-13-1



SPREADING LIGHT



LED Plafond PF 19

Surface mounted luminaires,
easy to mount directly to 230V
with diffused glass.

Diameter: Ø 190 mm
Height: 42 mm

Light beam 108°
Colour rendering index: RA>80
Energy efficiency category: A⁺

12 W, 3000°K, 1200 Lumen
Art.-No.
2-511-01-1

LED Plafond PF 30

Surface mounted luminaires,
easy to mount directly to 230V
with diffused glass.

Diameter: Ø 300 mm
Height: 42 mm

Light beam 110°
Colour rendering index: RA>80
Energy efficiency category: A⁺

26 W, 3000°K, 2000 Lumen
Art.-No.
2-511-02-1



SPREADING LIGHT



Square Wall LED

Wall lamps, white.
easy to mount directly to 230V

Dimensions: 105 x 105 x 70 mm
Energy efficiency category: A

6 W, 2700°K, 269 Lumen

Art.-No.

2-215-01-1





SPREADING LIGHT



Bend Wall LED

Wall lamps, white.
easy to mount directly to 230V

Dimensions: 120 x 200 x 70 mm
Energy efficiency category: A

7 W, 2700°K

Art.-No.
2-215-02-1





SPREADING LIGHT



Bend Wall Rounded LED

Wall lamps, white.
easy to mount directly to 230V

Dimensions: 180 x 190 x 95 mm
Energy efficiency category: A

7 W, 2700°K

Art.-No.

2-215-03-1





GLASS WALL LAMPS



Mini Queen Wall

with stainless steel backplate
Dimensions: 90 x 170 x 140 mm
Energy efficiency category: B - D
Socket: GY6,35 max. 12 V/50 W,
incl. transformer 70 W.

Art.-No.	version
2-752-71-2	glass white
2-752-72-2	glass black

Unica Mini Wall

with stainless steel backplate
Made of hand-blown glass.
Each glass is unique.
Dimensions: 90 x 170 x 140 mm
Energy efficiency category: B - D
Socket: GY6,35 max. 12V /50 W,
incl. transformer 70 W.

Art.-No.	version
2-274-03-1	glass white
2-274-03-2	glass black



FLEXIBLE WALL LAMPS



Spot Mini Queen

Made of hand-blown glass.
Each glass is unique.
Height of glass: 60 mm
Diameter of glass: Ø 80 mm
Energy efficiency category: B - D
Socket: GY6,35 max. 12 V/50 W
incl. transformer 70 W.

Art.-No.	version
2-221-71-3-1	white / chrome
2-221-72-3-1	black / chrome

Spot Unica Mini

Made of hand-blown glass.
Each glass is unique.
Height of glass: 110 mm
Diameter of glass: Ø 100 mm
Energy efficiency category: B - D
Socket: GY6,35 max. 12 V/50 W
incl. transformer 70 W.

Art.-No.	version
2-274-02-1-3	white / chrome
2-274-02-2-3	black / chrome



FLOOR & TABLE

Contact us for further details.

Scan Studio Lighting ApS
Tel.: +45 63 41 88 88
|@scanstudio.dk
www.scanstudiolighting.dk





TURN ON THE LIGHTS



Queen table

Height: 440 mm.

Energy efficiency category: B - D

Socket: GY6,35 max. 12 V/50 W

Art.-No.	version
2-221-71-3-2	white
2-221-72-3-2	black

Queen floor lamp

Height: 1400 mm.

Energy efficiency category: B - D

Socket: GY6,35 max. 12 V/50 W

Art.-No.	version
2-221-71-3-3	white
2-221-72-3-3	black

Available in several colours,
call us for more info.





GET ON THE FLOOR



Unica floor lamp (see fig. A)

Height: 1400 mm.

Energy efficiency category: B - D

Socket: GY6,35 max. 12 V/50 W

Art.-No.	version
-----------------	----------------

2-271-00-3-1	white
--------------	-------

2-271-00-3-2	black
--------------	-------

Unica Mini floor lamp (see fig. B)

Height: 1400 mm.

Energy efficiency category: B - D

Socket: GY6,35 max. 12 V/50 W

Art.-No.	version
-----------------	----------------

2-274-00-3-1	white
--------------	-------

2-274-00-3-2	black
--------------	-------

Available in several colours,
call us for more info.

Ceres floor lamp (see fig. C)

Height: 1400 mm.

Energy efficiency category: B - D

Socket: GY6,35 max. 12 V/50 W

Art.-No.	version
-----------------	----------------

2-273-00-3-1	white
--------------	-------

2-273-00-3-2	black
--------------	-------



MATCHING TABLE LAMPS



Unica Mini table (see fig. A)
Height: 440 mm.
Energy efficiency category: B - D
Socket: GY6,35 max. 12 V/50 W

Art.-No.	version
2-274-01-1-3	white
2-274-01-2-3	black

Ceres table (see fig. B)
Height: 440 mm.
Energy efficiency category: B - D
Socket: GY6,35 max. 12 V/50 W

Art.-No.	version
2-244-01-3	white
2-244-02-3	black

Classic table (see fig. C)
Height: 440 mm.
Energy efficiency category: B - D
Socket: GY6,35 max. 12 V/50 W

Art.-No.	version
2-247-11-3	white





Scan Studio Lighting ApS
Dangaardvej 2
Dk-5500 Middelfart

Tel.: +45 63 41 88 88
Fax: +45 63 41 88 00

[l@scanstudio.dk](mailto:info@scanstudio.dk)
www.scanstudiolighting.dk

LIGHTS
OUT

See you at Scan Studio Lighting



Scan Studio Lighting ApS
Damgaardvej 2
Dk-5500 Middelfart

Tel.: +45 63 41 88 88
Fax: +45 63 41 88 00

l@scanstudio.dk
www.scanstudiolighting.dk